

UNUSED
TX AMP
BA728

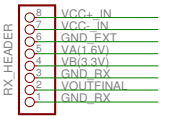

Top and Bottom Layers

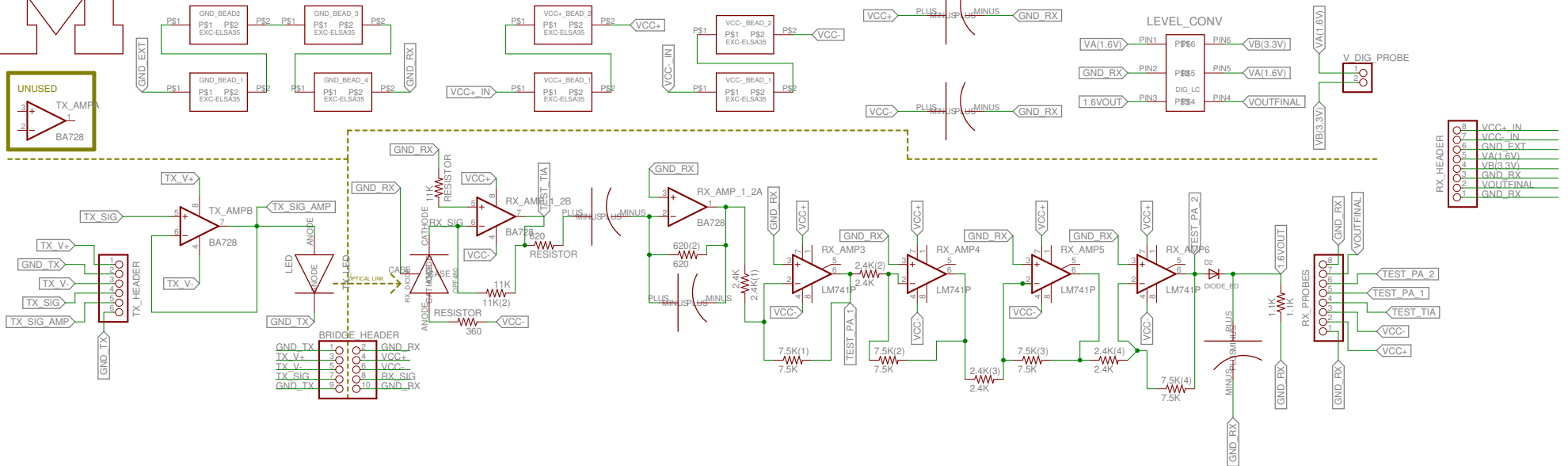
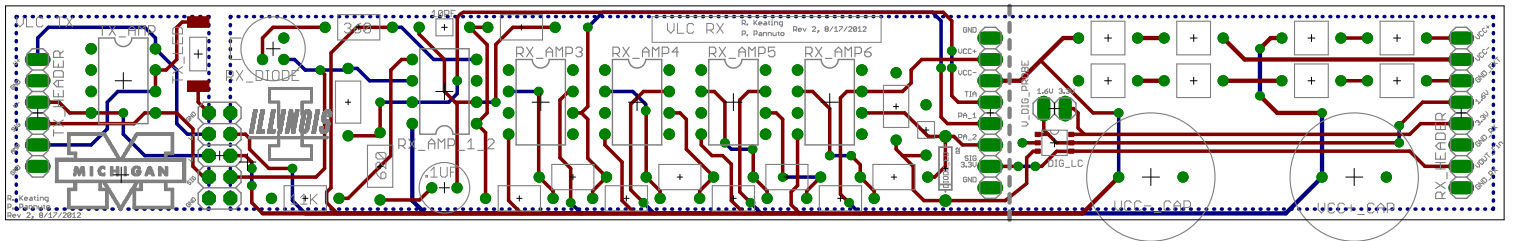

Top Layer

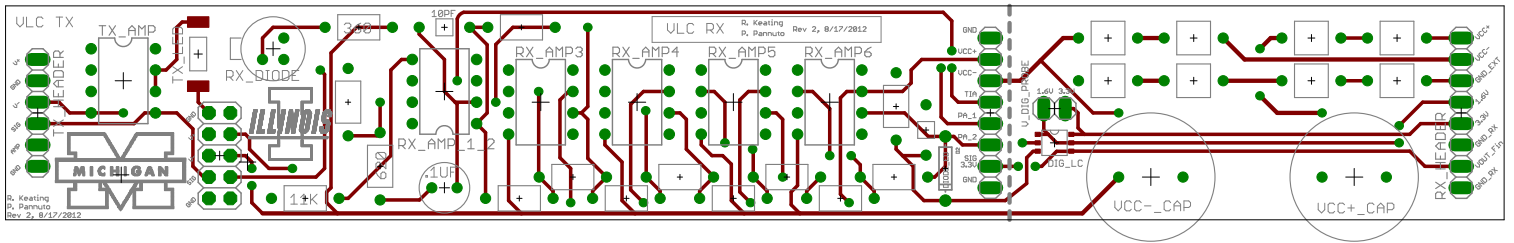

Bottom Layer

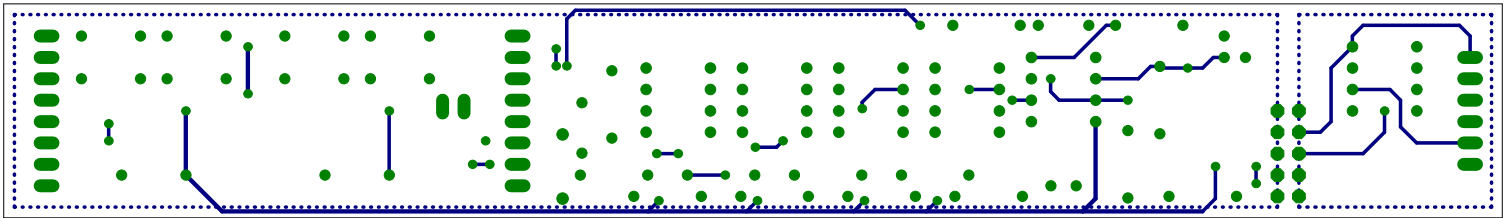

Top Copper Layer

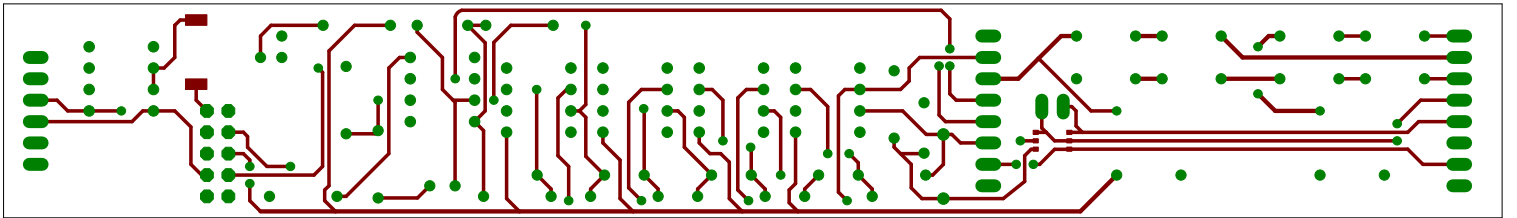

Bottom Copper Layer

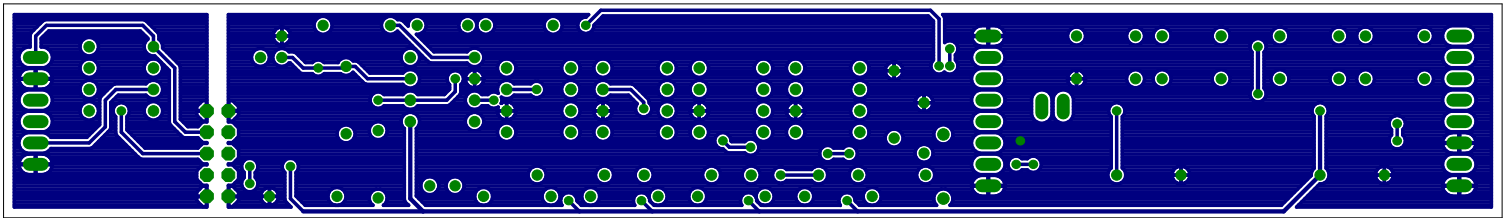

Bottom Paste Layer with Silkscreen

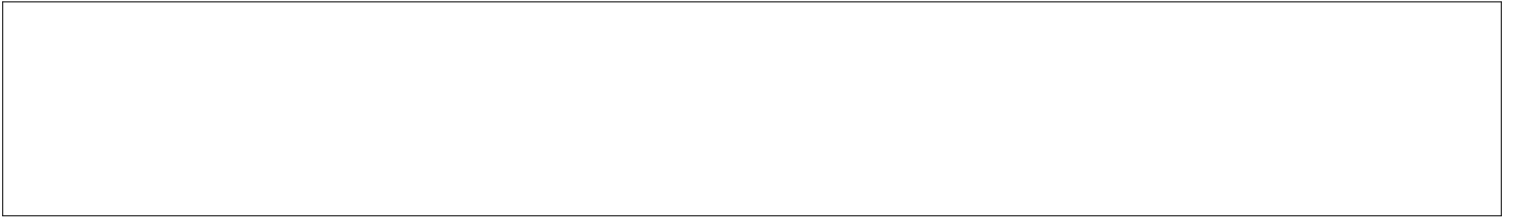

Top and Bottom Layers 1:1 Scale

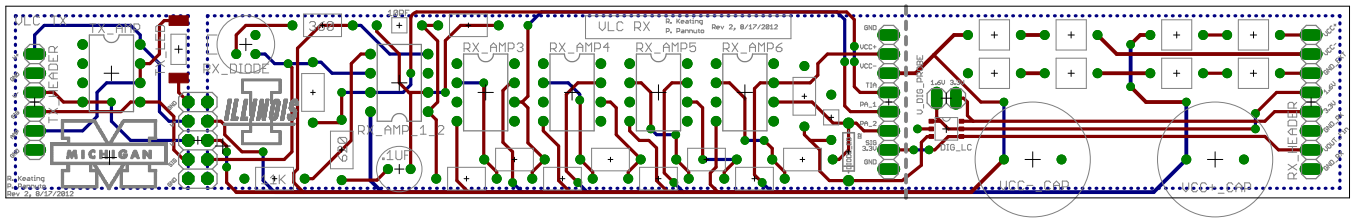

Top Layer 1:1 Scale

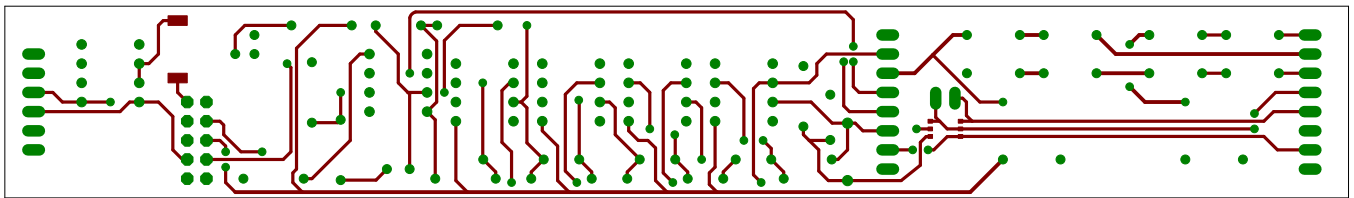

Bottom Copper Layer 1:1 Scale

